

LEŠENIE 70 x 250 • OBJÍMKY

Lešenie s prefabrikovanými rámmi s objímkami, s rozstupom medzi rámmi 250 a 70 cm šírky. Toto lešenie môže byť dodávané lakované i pozinkované. Je mimoriadne vhodné pre údržbárske práce v stavebníctve i v priemyselnej oblasti.

Lešenie navrhnuté pre zataženie 150 daN/m² je vybavené pozinkovanými kovovými doskami s konštrukčnou funkciou, s príslušnou okopovou zarážkou, prístupovými doskami s priezdom a rebrikom, nosníkmi zábradlia na poslednom poschodí, ochrannými krytmi, tyčami zábradlia s dĺžkou 100 a 200 cm a spodnými nastaviteľnými pätkami. Lešenie 70 x 250 je prvé integrované lešenie, ktoré môže byť priradené k lešeniu 105 s použitím tých istých komponentov, čo je z ekonomického hľadiska veľmi výhodné.

70X250 FRAME SCAFFOLDING WITH BUSH COUPLING

Prefabricated frame scaffolding with 250x70 cm deck space between frames. Both painted and hot-dip galvanised versions are available. This scaffolding is particularly indicated for building and industrial maintenance.

Designed for loads up to 150 daN/m², it comes with hot-dip galvanised metal boards that have a structural function with corresponding safety toeboards, hatch decks with drop-down stairs, end guardrails, gravel guards, 100 and 200 cm guardrail tubes and hot-dip galvanised, adjustable base plates. The 70x250 cm scaffolding is the first to be integrated and can be combined with Sicurpont H 105 using the same components, thus favouring building-site economy.

Zloženie rámov vo zvislom smere Vertical frame structure

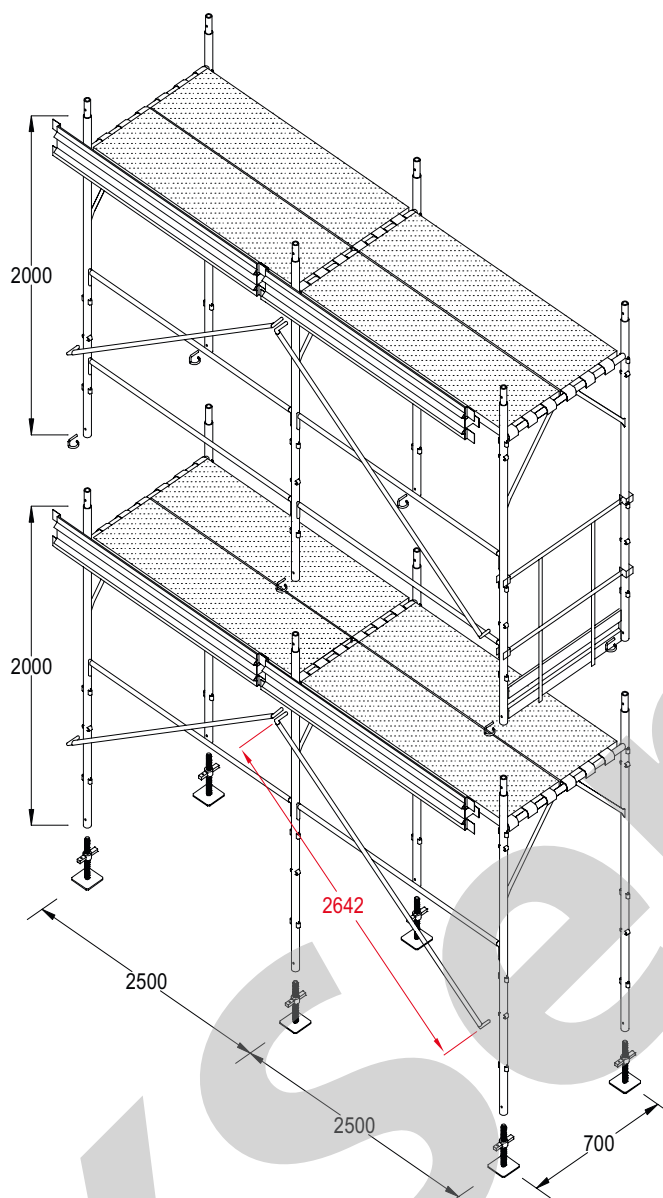

PRVKY, KTORÉ HO TVORIA SCAFFOLD COMPONENTS

Hĺbka Width	Rozstup Length	Modul s nemennou výškou Fixed height module
700 mm	2500 mm	2000 mm

Componenti per ponteggi a boccole

Scaffolding with bush couplings components

Telaio <i>Frame</i>	Codice <i>Code</i>
70x250 cm	90-2601

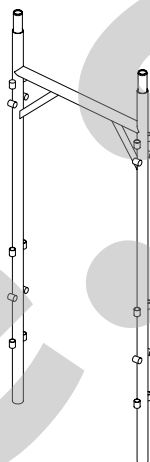

Mezzo telaio <i>Half frame</i>	Codice <i>Code</i>
70x250 cm	90-2606

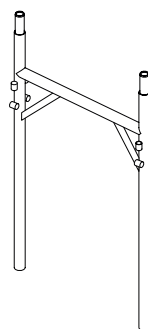

Telaio <i>Frame</i>	Codice <i>Code</i>
Comipont 105	90-1001
Comipont 2	90-1013

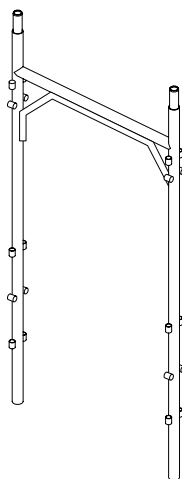

Mezzo telaio <i>Short frame</i>	Codice <i>Code</i>
105	90-1006

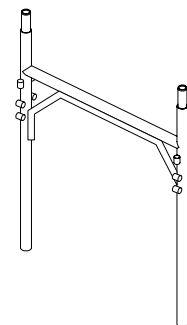

Basetta regolabile <i>Adjustable base plates</i>	Codice <i>Code</i>
cm 35	90-3003
cm 50	90-3004



Basetta regolabile <i>Adjustable base plates</i>	Codice <i>Code</i>
cm 75	90-3005
cm 100	90-3006



Basetta semplice <i>Simple base plate</i>	Codice <i>Code</i>
	90-3001

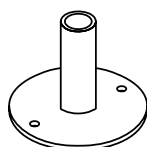

Gancio assiale <i>Connection hook pin</i>	Codice <i>Code</i>
	90-2707Z

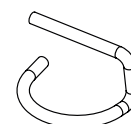

Componenti per ponteggi a boccole

Scaffolding with bush couplings components

Corrente parapetto <i>Guardrail ledger</i>	Codice <i>Code</i>
1050 mm	90-1005
1800 mm	90-1002
2500 mm	90-2702

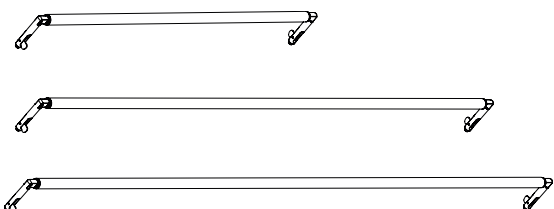

Corrente di testata <i>End ledger</i>	Codice <i>Code</i>
700 mm	90-2605
1050 mm	90-1005

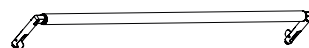

Diagonale in pianta e in vista per campi da <i>Horizontal and vertical braces for a length of</i>	Codice <i>Code</i>
A-B 2500 mm	90-2703
A-B 1050 mm	90-2708
A-B 1800 mm	90-1003
B 1800 mm	90-1015

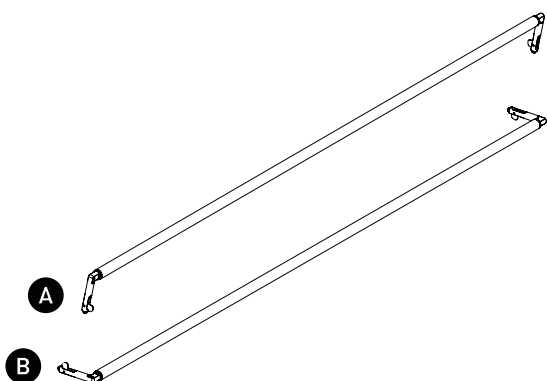

Parasassi Ø 48 <i>Gravel Guards</i>	Codice <i>Code</i>
	90-3032

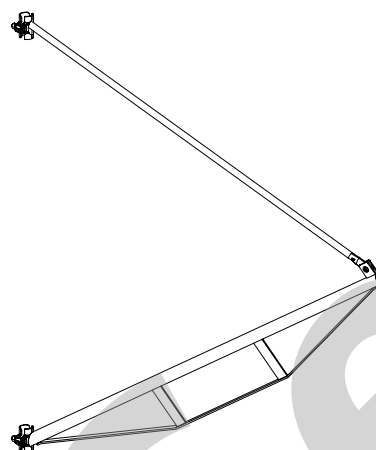

Mensola a sbalzo <i>External bracket</i>	Codice <i>Code</i>
700 mm	90-3008
1050 mm	90-3007

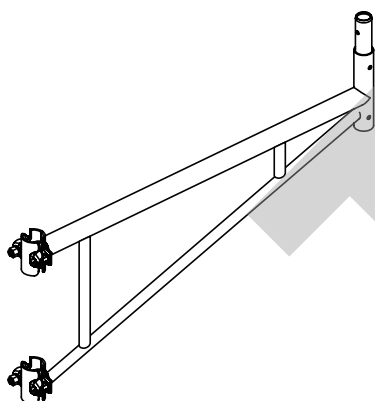

Puntone per mensola <i>Bracket prop</i>	Codice <i>Code</i>
700 mm	90-3084 B
1050 mm	90-3084

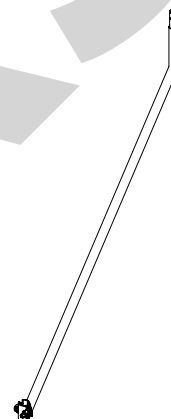

Componenti per ponteggi a boccole

Scaffolding with bush couplings components

Spodný rám
pre úzky rozjazd
*Lower frame for narrow
carriage entrance*

Codice
Code

550 mm

90-2010

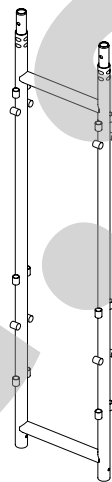

Horný rám pre rozjazd s
výčnelkom
*Upper frame for overhanging
carriage entrance*

Codice
Code

550-1050 mm

90-2011

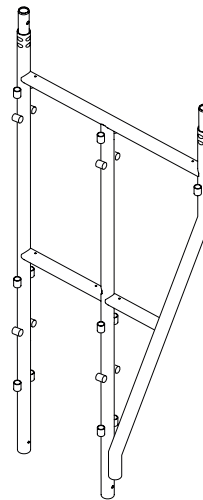

Rám pre prechod chodcov
*Frame for
walkway access*

*Frame for
walkway access*

700-1050 mm

Codice
Code

90-2013

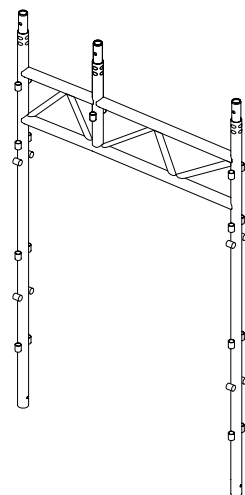

Tyče zábradlia
Guardrail tubes

Codice
Code

1000 mm

90-3009

2000 mm

90-3012

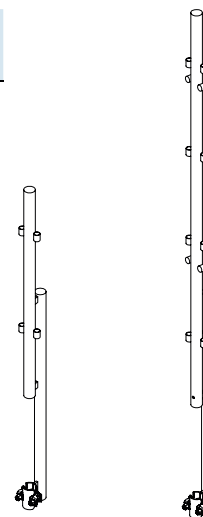

Ukotvenie skrutkou s
hákom Ø 22 mm
*Anchor screw with Ø 22
mm hook*

Codice
Code

90-3033

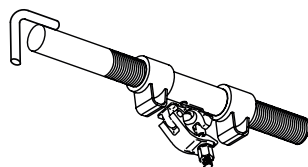

Rúrkové ukotvenia
Tube pin anchors

Codice
Code

A - Ø 22

90-3060Z

B - Ø 48

90-3062Z

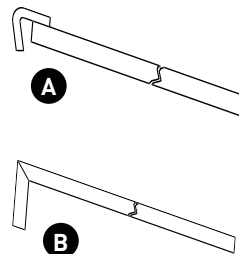

Nosník vjazdu do domu
Beam for walkway

Codice
Code

3600 mm

90-2513

5000 mm

90-2515

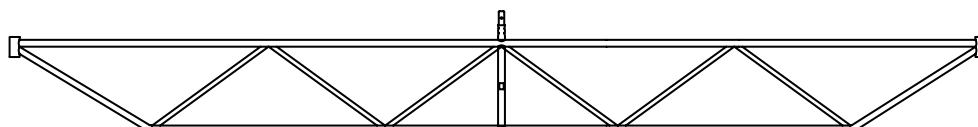

Doska sicurblock s rozmerom 330 mm <i>330 mm clinciata plank</i>	Codice Code
2500 mm	90-3024 Z
2000 mm	90-3045 Z
1800 mm	90-3039 Z
1500 mm	90-3046 Z
1250 mm	90-3047 Z
1110 mm	90-3048 Z
1000 mm	90-3049 Z

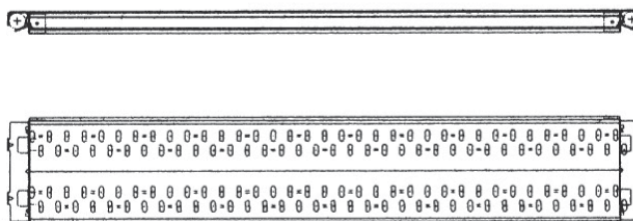

Doska sicurblock s rozmerom 500 mm <i>500 mm clinciata plank</i>	Codice Code
1800 mm	90-3026 Z
1050 mm	90-3038 Z

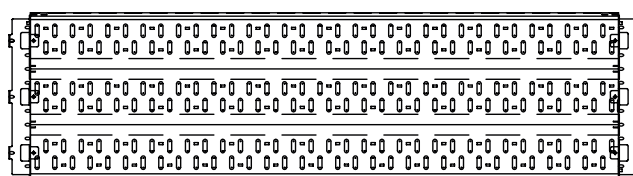

Doska s prielezom sicurblock <i>Hatch deck</i>	Codice Code
500x1800 mm	90-3028 Z
660x2500 mm	90-3037 Z

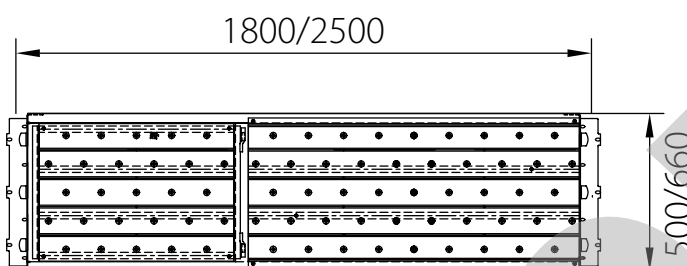

Doska s prielezom 500 mm <i>500 mm hatch deck</i>	Codice Code
attacco DX - 1800 mm <i>Right</i>	90-3027 DX
attacco SX - 1800 mm <i>Left</i>	90-3027 SX

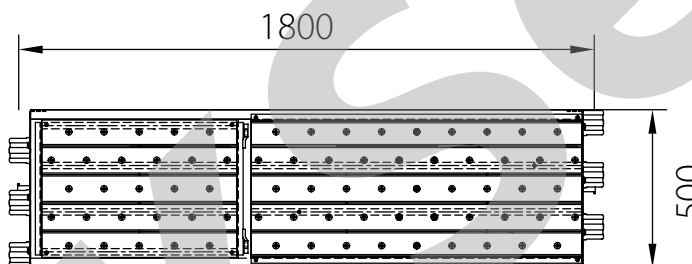

Doska s prielezom 500 mm <i>500 mm clinciata plank</i>	Codice Code
attacco DX - 1800 mm <i>Right</i>	90-3025 DX
attacco SX - 1800 mm <i>Left</i>	90-3025 SX

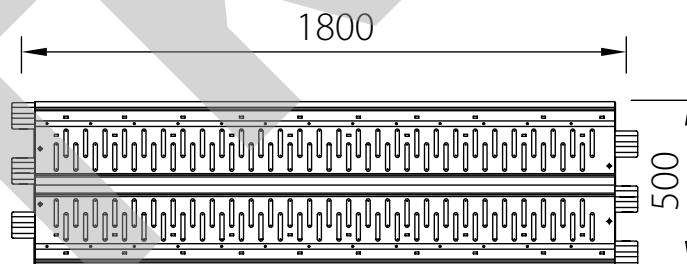

Componenti tavole metalliche

Metallic plank components

Doska okopovej zarážky čelnej časti <i>Head toeboard</i>	Codice <i>Code</i>
1110 mm	90-3059
1050 mm	90-3029
700 mm	90-3058



Doska okopovej zarážky H 200 mm <i>200 mm H toeboard</i>	Codice <i>Code</i>
2500 mm	90-3070
2000 mm	90-3065
1800 mm	90-3031
1500 mm	90-3066
1250 mm	90-3067
1110 mm	90-3068
1000 mm	90-3069

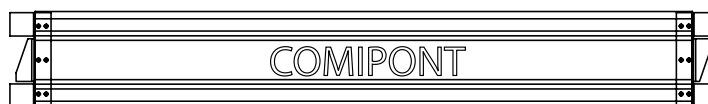

Kompenzačná doska <i>Compensation plank</i>	Codice <i>Code</i>
2500 mm	90-3110
2000 mm	90-3111
1800 mm	90-3112
1500 mm	90-3113
1250 mm	90-3114
1110 mm	90-3115
1000 mm	90-3116

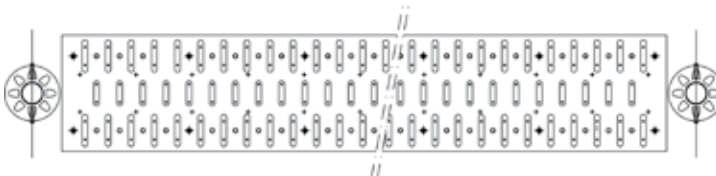

Rebrík pre priele <i>Ladder for hatch deck</i>	Codice <i>Code</i>
	90-3023 Z

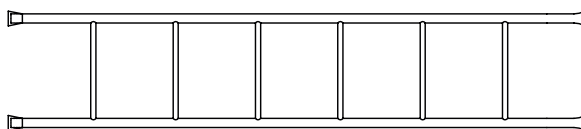

Hliníková/viacvrstvová doska s prielezom <i>Multilayered aluminium hatch deck</i>	Codice <i>Code</i>
2500 mm	90-3071
1800 mm	90-3057

